

AS6031-QF_DK

Development Kit User Guide

AS6031-QF_DK User Guide

Revision: 6

Release Date: 2023-02-10

Document Status: Production

Content Guide

Content Guide	2
1 Introduction	3
1.1 Ordering Codes	3
2 Quick Start Guide	4
3 Hardware Description	5
3.1 Introduction	5
3.2 Communication Interface	5
4 UFC Evaluation Software	6
5 Schematics, Layers & BOM	14
6 RoHS Compliance & SciSense Green Statement	17
7 Copyrights & Disclaimer	17
8 Revision information	18

1 Introduction

The AS6031-DK development kit allows customers a quick and intuitive approach to using the AS6031 UFC in ultrasonic flow meter applications.

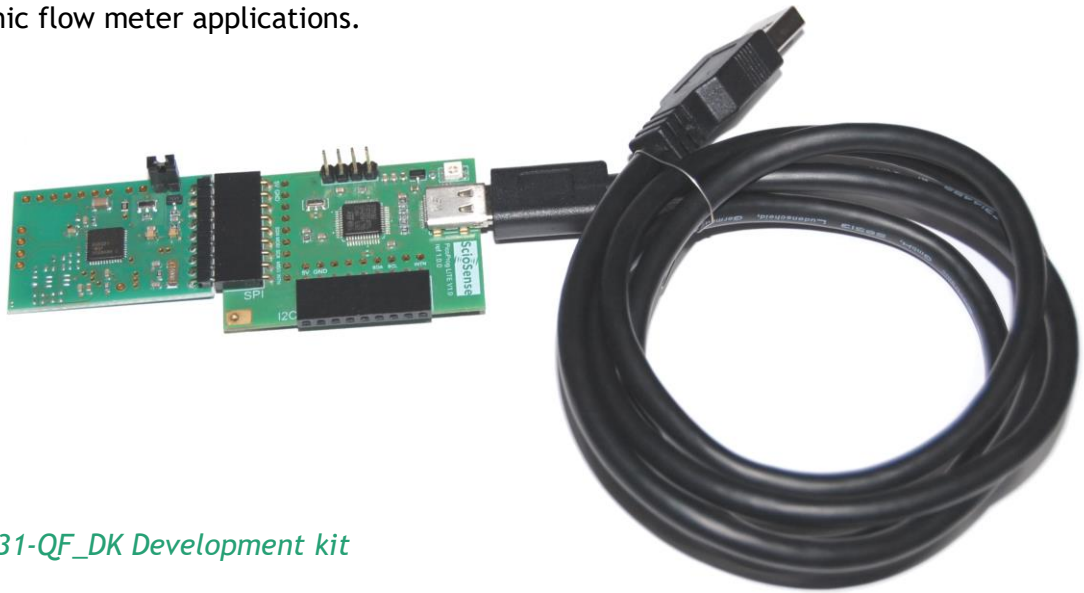

Figure 1: AS6031-QF_DK Development kit

The kit includes the following elements:

AS6031-QF_DK_RB reference board V2.0

PicoProg Lite with USB-C – USB cable

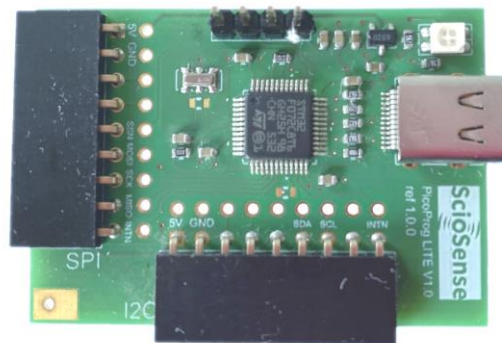
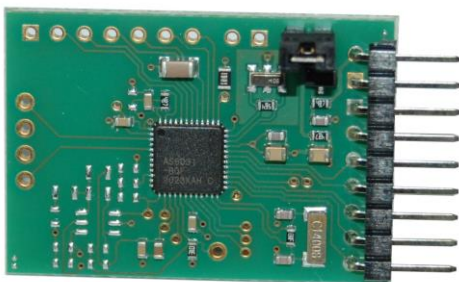

Figure 2: Functional Blocks

Please download the software for the kit from <https://downloads.sciosense.com/as6031> and look for the latest version of UfcEvaluationSoftware....zip.

1.1 Ordering Codes

Table 1: Pin description

Ordering code	Part Number	Description
AS6031-QF_DK V1.0	221020003	AS6031 Demo kit including PICOPROG and cables
AS6031-QF_DK_RB V2.0	221020002	AS6031 reference board

2 Quick Start Guide

This section describes how to quickly set up the AS6031 development kit, to establish basic operation and to make first measurements.

Please install the software before connecting the evaluation kit to your computer. The software can be downloaded here: <https://downloads.sciosense.com/as6031>

- Unzip the package to the desired directory,
- Connect the PicoProg Lite to the computer and the AS6031 board to the SPI connector on the PicoProg Lite.
- Connect your spool piece to US_UP and US_DOWN. US_UP fires upstream, means versus flow. US_DOWN fires downstream, with the flow.
- Open “UFCEvaluationSoftware.exe”

The following screen will appear:

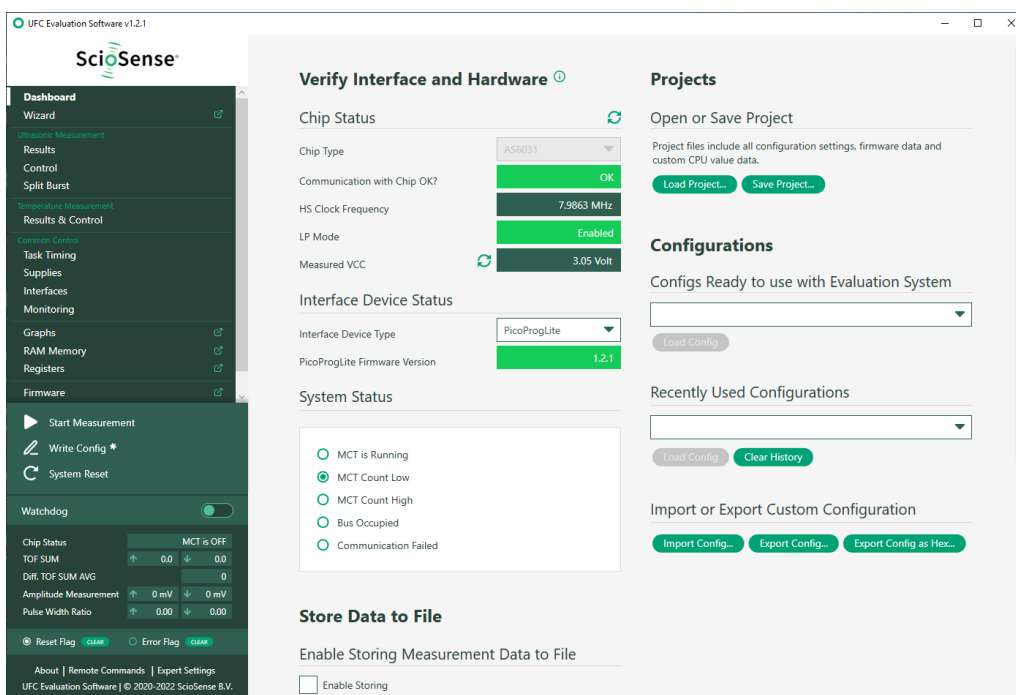

Figure 3: Opening page

- Verify that the right device is selected and interface status is ok.
- Select a project or one of the ready configuration files, press “Load Project” or “Load Config” and then on the left side press “Write Config”.
- Finally, press “Start Measurement” to begin measuring.

3 Hardware Description

3.1 Introduction

The AS6031-QF_DK_RB board, shown in figure 3, is a front-end for a water or heat meters. The transducers and temperature sensors can be connected to this board directly. It comes with a 32.768 kHz quartz (X2) and a 8 MHz ceramic oscillator (X1).

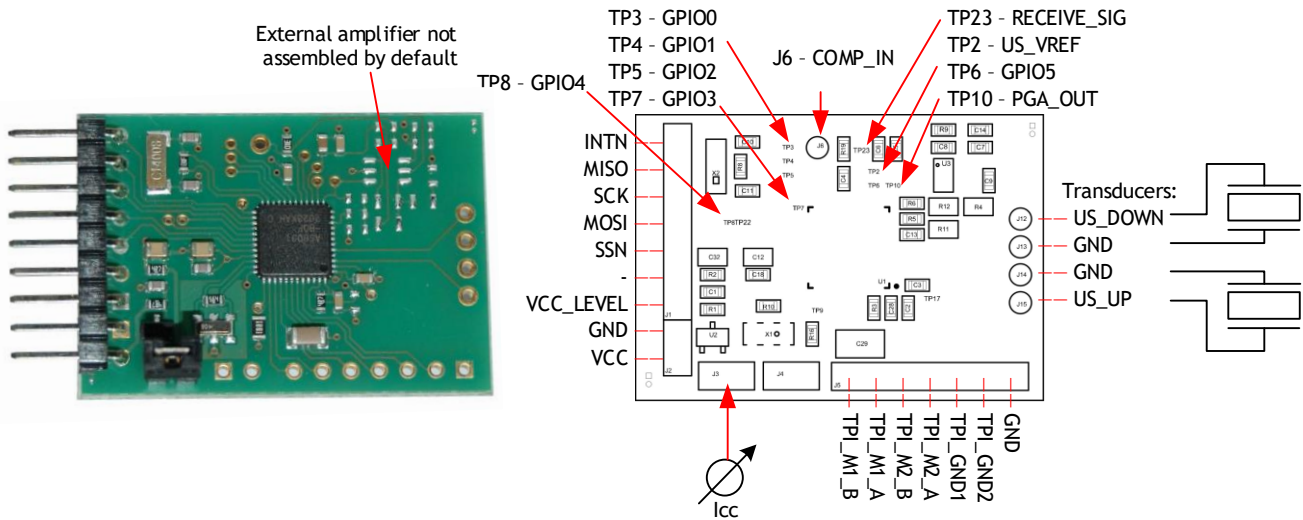

Figure 4: AS6031-QF_DK_RB

3.2 Communication Interface

The PicoProg Lite is a USB-to-SPI converter that connects the AS6031 board to a PC. The PICOPROG is registered by the operating system initially as “PicoProg LITE V1.0”. The board converts SPI into USB communication. The USB connector is a USB-C one.

The PicoProg Lite comes with two connectors, one for SPI communication and one for I2C communication. For the AS6031 please use the SPI connector.

PicoProg Lite reads interrupt-triggered from the AS6031 board.

4 UFC Evaluation Software

The software opens with the dashboard window. It should detect the connected board automatically and indicate operability by green status information (1).

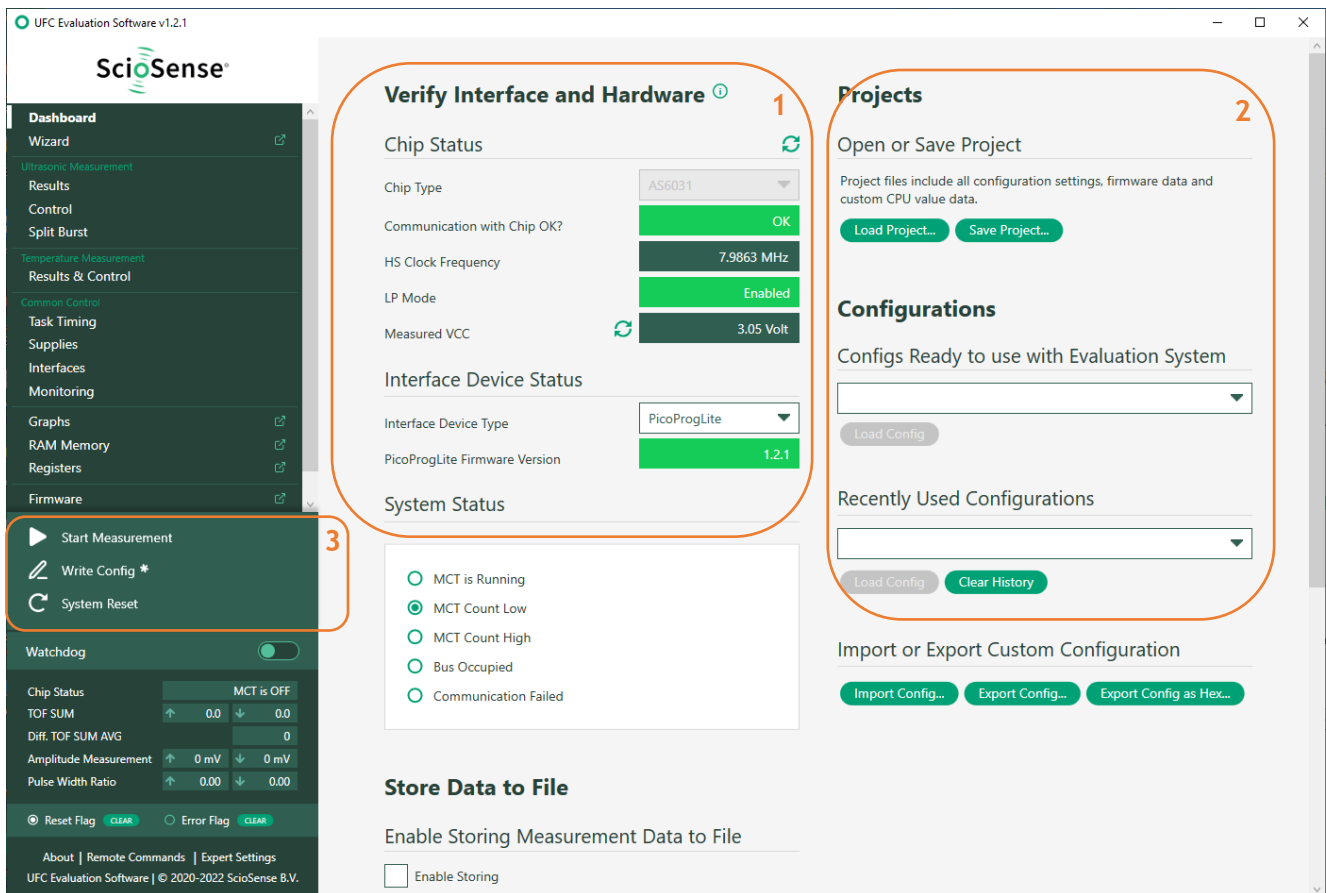

Figure 5: Dashboard

The next steps could be to start with one of the default configurations, an existing project or an existing configuration by loading it into the GUI. To write the Data to the Chip you need to click on “Write Config” and then you can start the measurement (3).

Note: when you change parameters in the GUI this is indicated by a star behind “Write Config” (3). Do the write to make sure the chip has the current configuration. The star will then disappear.

Projects include the complete settings of the GUI, including the configuration, the firmware and firmware data, the settings for CPU window and flags.

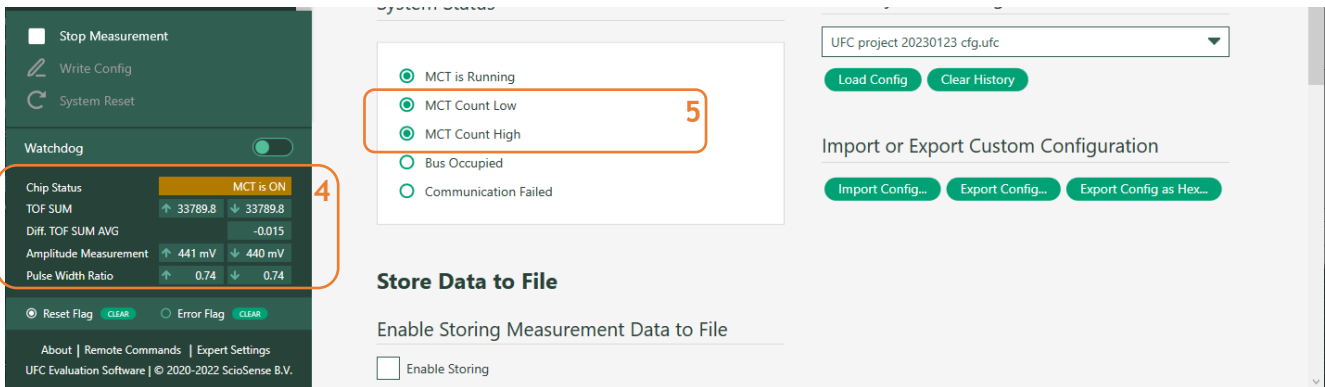

Figure 6: Dashboard active

On the left green bar the main measurement results are displayed: chip status, time-of-flight (TOF), difference up-down (TOF Difference), amplitude and pulse width ratio (4).

The flags for the measure cycle (5) timer should toggle for an active measurement. The results page will show the detailed ToF results:

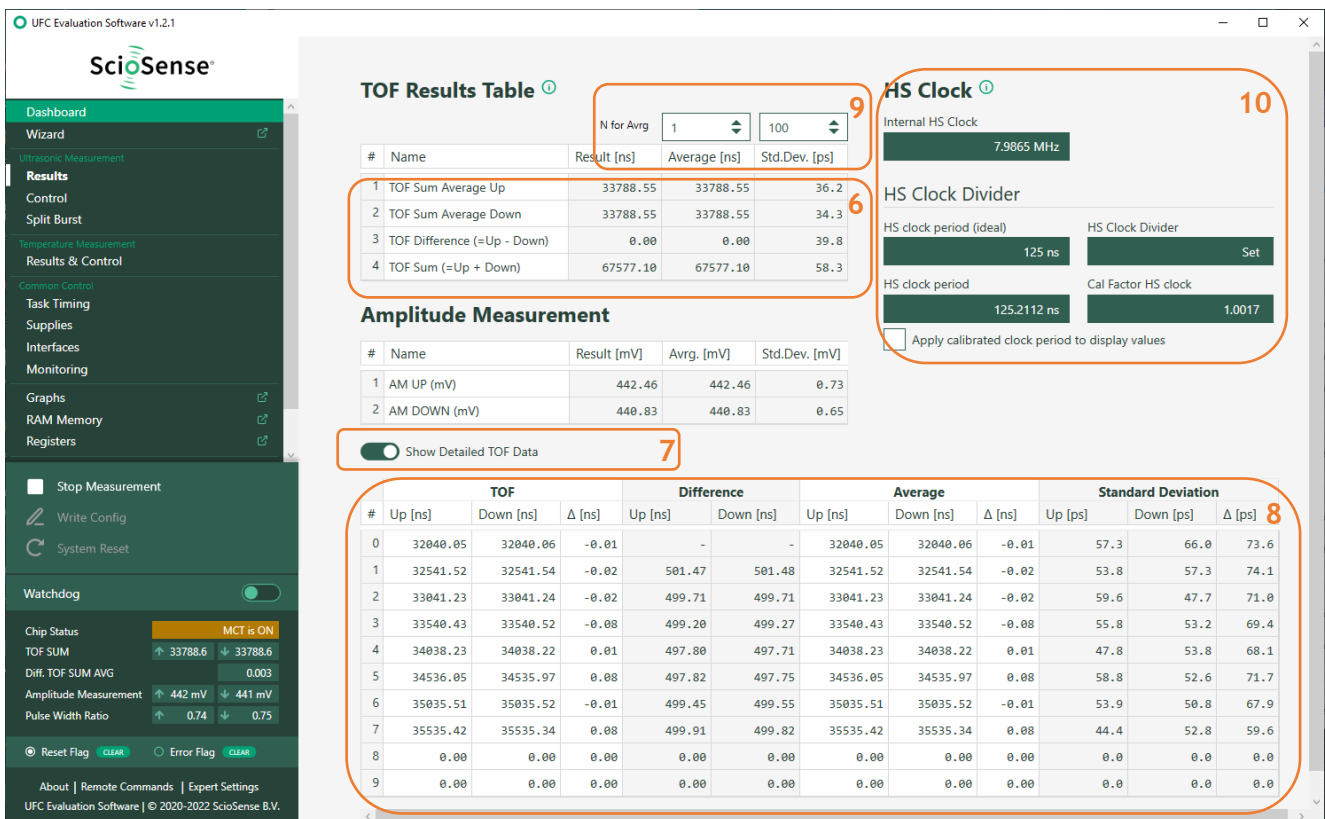

Figure 7: Results page

The ToF results table (6) shows the average of the selected zero crossings per measurement in up and down direction, the difference of up and down (proportional to the flow rate), and the sum of up and down (proportional to speed of sound). By selecting detailed data (7) an additional table pops up that shows each individual zero crossing measurement (8).

The “no. of Avrg.” (9) define the numbers of samples for a software average in the GUI. The number on the right, above Std.Dev. define the number of samples used in the mathematics for the calculation of the standard deviation.

The HS Clock block shows the measured period of the high speed clock and the correction factor in comparison to the ideal value. There is a select option for application of this correction factor to the measurement results (10).

The control page shows the main parameters for setting the ultrasonic frontend.

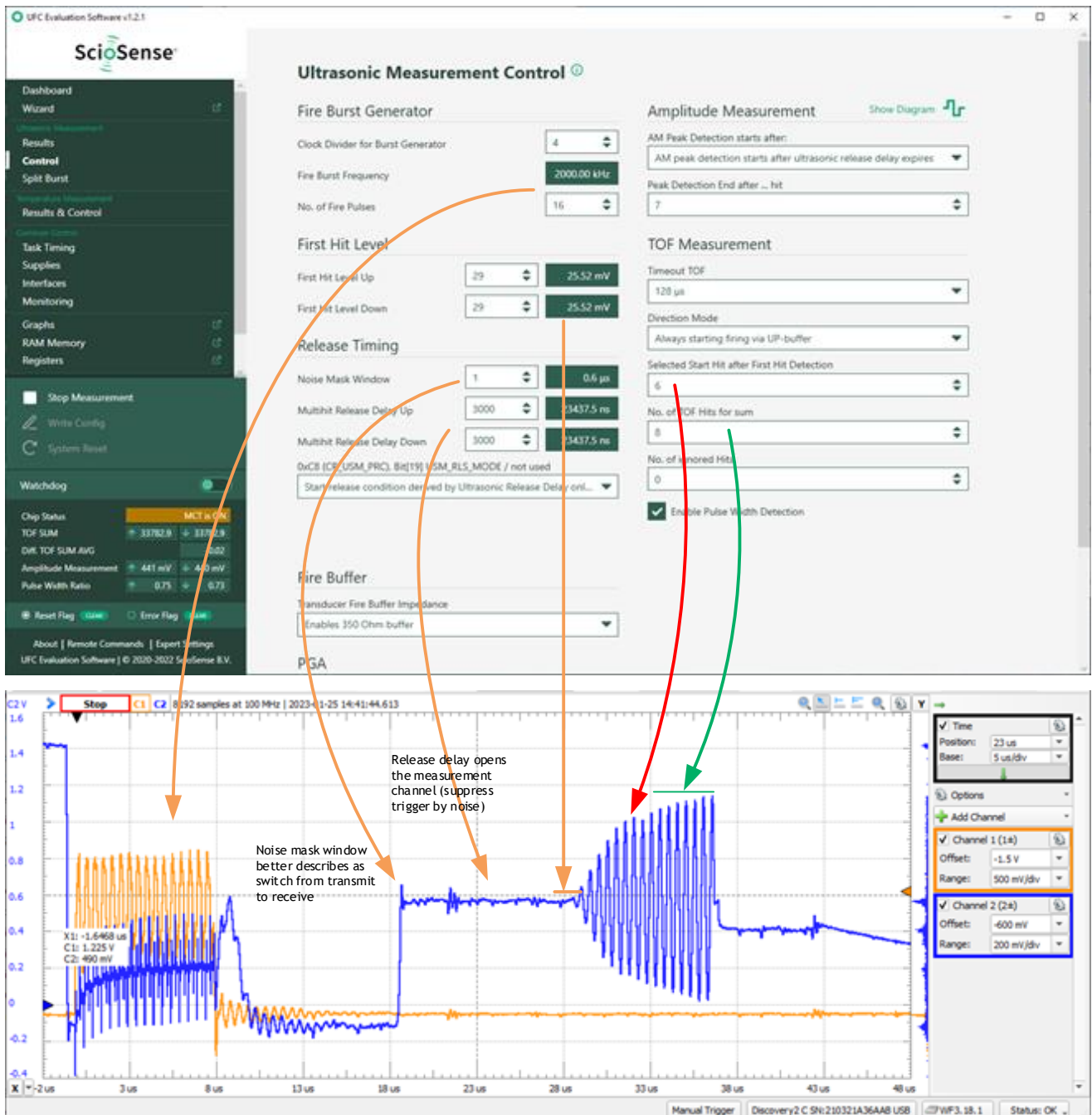

Figure 8: Control page

In this page you set the fire frequency, derived from the high speed clock.

With the noise mask window you set the time when to switch from sending to receiving.

The release delay sets the end of a window to suppress wrong triggers by noise.

The first hit level defines the voltage level for the comparator to detect the first hit of the receive burst.

The start hit defines how many waves to wait after first hit level detection before starting collection of ToF data. This time is typically needed by the transducers to follow the fixed fire frequency and to oscillate with a stable period.

The number of ToF hits defines how many zero crossings are summarized for a single measurement in either up or down direction.

Finally, the gain of the PGA is set on this page, too.

Another important page is the Task Timing page:

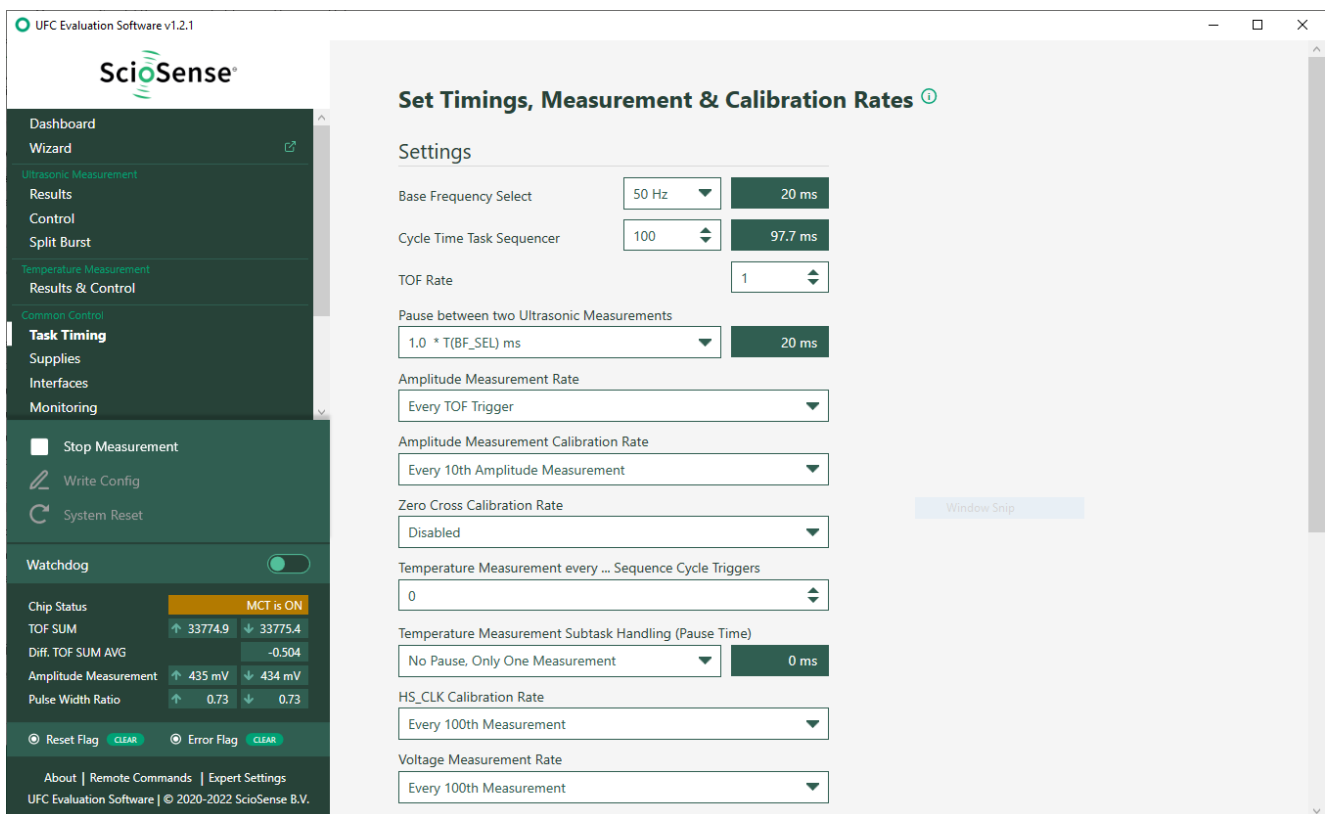

Figure 9: Task timing page

Here you define the sample rate as a combination of the cycle time and the TOF rate (one ToF every N cycles, N typically 1).

Besides the numerical display of the result page the software offers an export of the data into a file as well as a graphical display (which could be found in the graphs page).

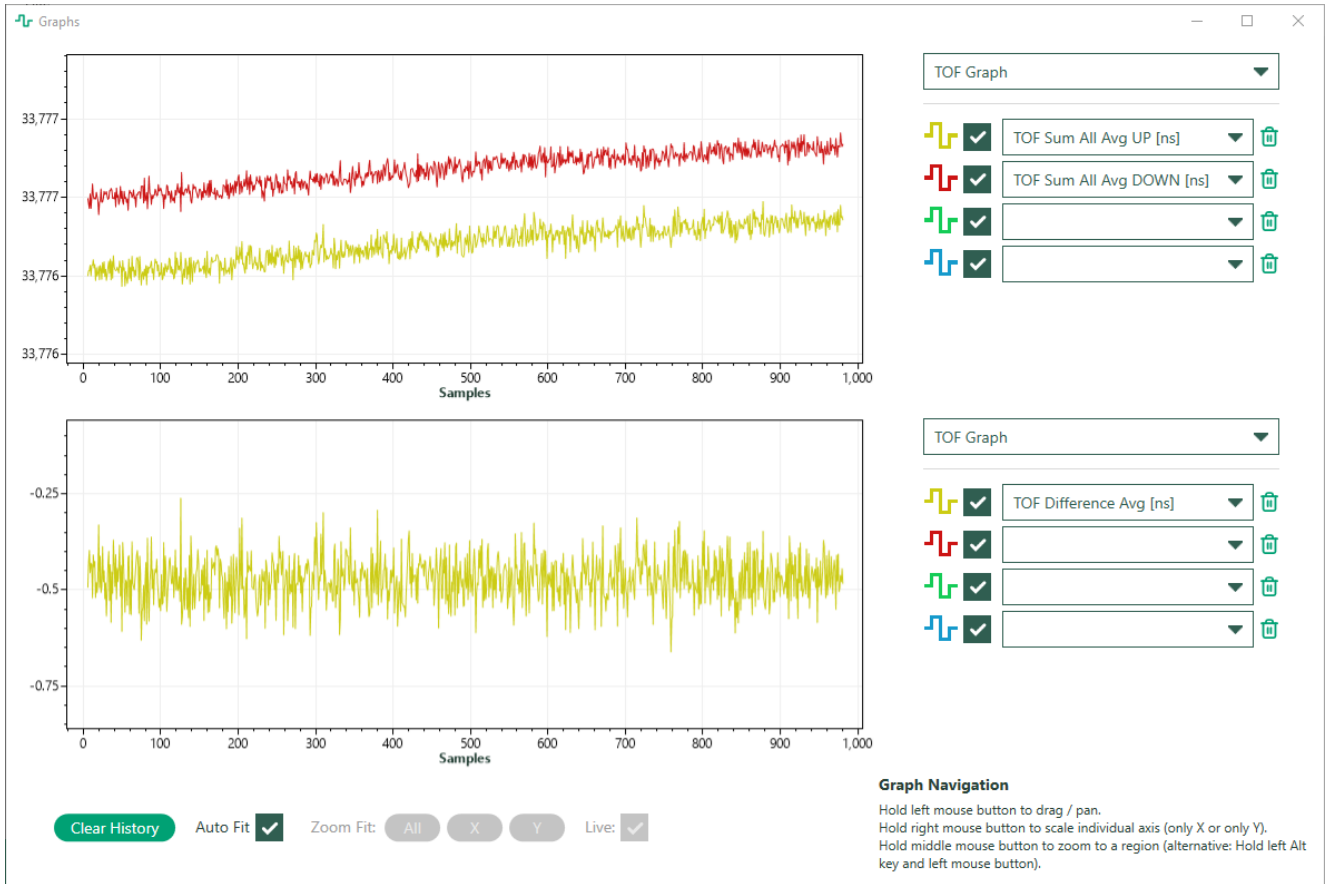

Figure 10: Graphs page

The parameters to be displayed are selectable. By means of the CPU window, any RAM cell can be reported and also graphically displayed.

The export to file is enabled on the main dashboard. The user can select which values should be imported.

Note that the file is working with placeholders which means that the selection can be changed any time during data acquisition. So you may start with ToF data only, and when you see unexpected behavior then you can add amplitude e.g..

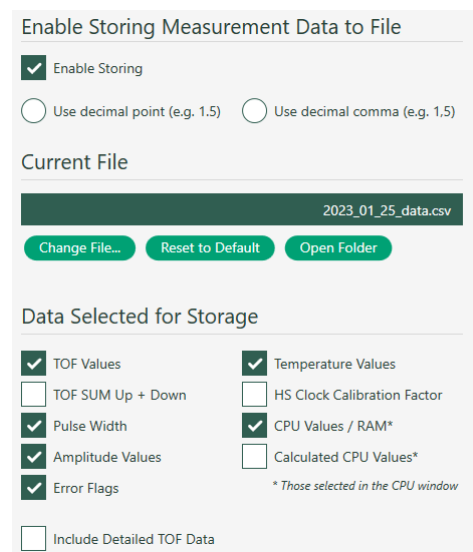

Figure 11: Export selection

The CPU values themselves are defined in the CPU values window and need to correlate with the firmware in the chip. Below is an example of the ScioSense AS6031-F1 Version.

Note: AS6031F1 is a variant of the AS6031 ultrasonic flow converter that comes with a protected flow firmware by ScioSense already programmed into the NVRAM. Based on these algorithms and together with the appropriate calibration and operation parameters, the chip is ready to do the complete flow and volume calculation as well as error handling on chip.

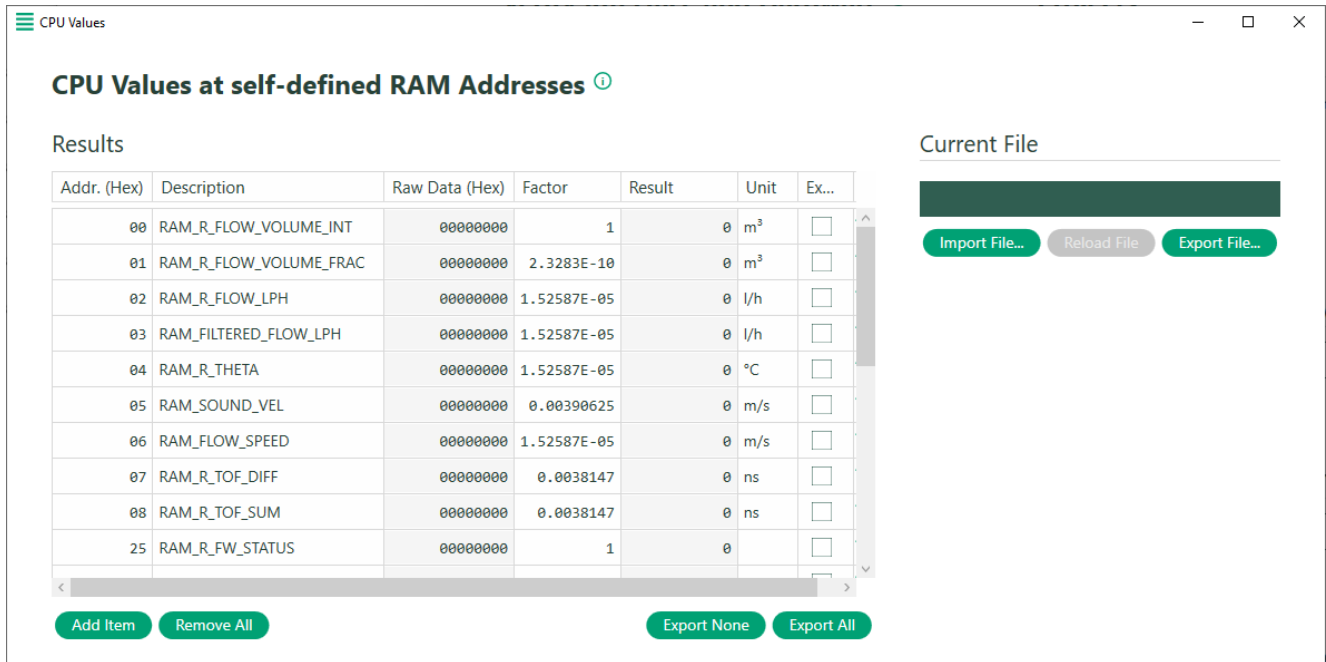

Figure 12: CPU values example

The monitoring page allows to select flags to be displayed and the flags themselves in action.

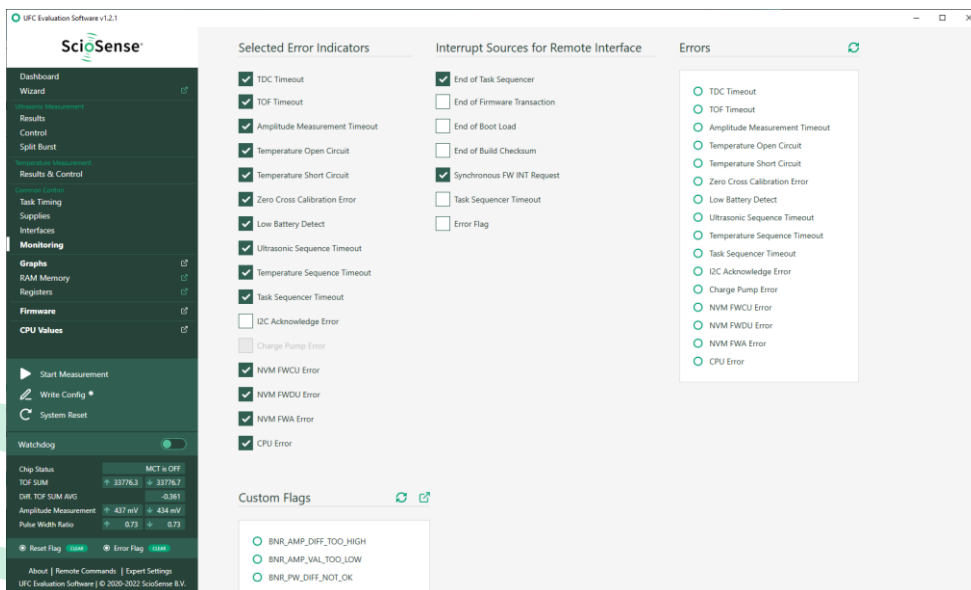

Figure 13: Monitoring page

For applications with firmware on the chip it is possible to add custom flags according to the firmware. The definition is made in the firmware window.

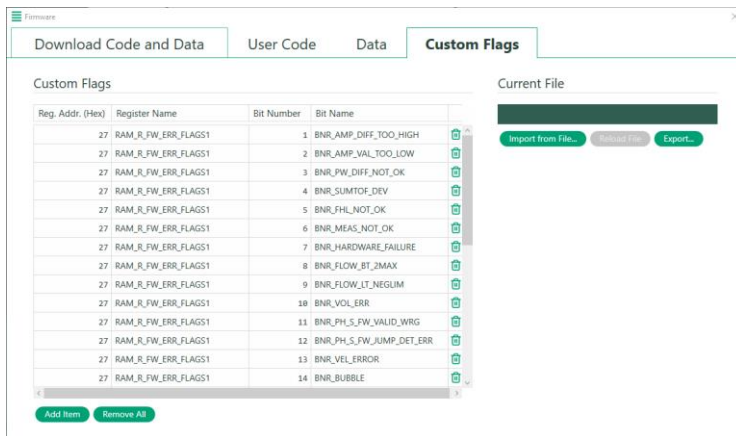

Figure 14: Monitoring Example custom flags

If you want to work with firmware on the AS6031 the you need the Firmware window.

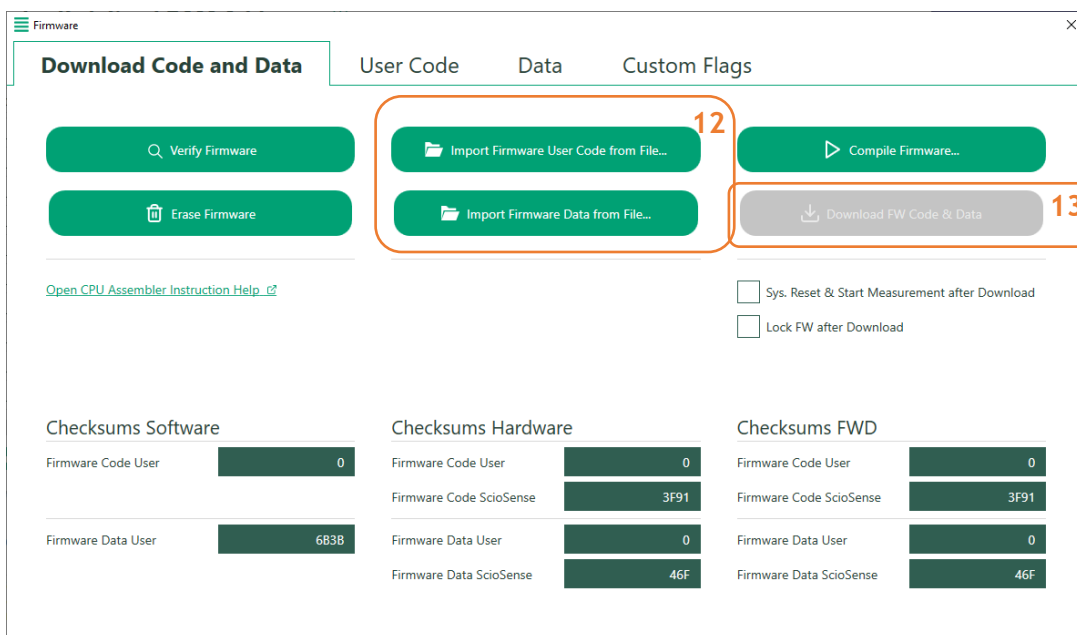

Figure 15: Firmware window

On the main page you can load the files with the firmware hex code and the firmware data (12). You download them (13) and monitor the checksums to see the success of the process.

The User Code page sets a focus to the firmware hex file.

The Data page allows to review the firmware data in detail, to add a description and also a scaling factor to convert the integer value into a reasonable physical value.

The assembler converts a text file into a hex file. There is no editor integrated. We recommend standard text editors like Notepad++.

FW Data

#	Name	Signed	Value (dec)	Value (hex)	Factor	Calculated
0	FWD_FWU_CS user code check	<input type="checkbox"/>	115021	0001C14D	1	115021
1	FWD_FWU_CS user data chec	<input type="checkbox"/>	27283	00006A93	1	27283
2	FWD_JUMP_FLAG	<input type="checkbox"/>	1	00000001	1	1
3	FWD_ERROR_COUNT_CONF1	<input type="checkbox"/>	4294967295	FFFFFFFF	1	4294967295
4	FWD_ERROR_COUNT_CONF2	<input type="checkbox"/>	4294967295	FFFFFFFF	1	4294967295
5	FWD_ERROR_COUNT_21	<input type="checkbox"/>	0	00000000	1	0
6	FWD_ERROR_COUNT_43	<input type="checkbox"/>	0	00000000	1	0
7	FWD_ERROR_COUNT_INV21	<input type="checkbox"/>	4294967295	FFFFFFFF	1	4294967295
8	FWD_ERROR_COUNT_INV43	<input type="checkbox"/>	4294967295	FFFFFFFF	1	4294967295
9		<input type="checkbox"/>	0	00000000	1	0
10		<input type="checkbox"/>	0	00000000	1	0
11		<input type="checkbox"/>	0	00000000	1	0
12		<input type="checkbox"/>	0	00000000	1	0
13		<input type="checkbox"/>	0	00000000	1	0
14		<input type="checkbox"/>	0	00000000	1	0

Current File

Import from File... Reload File
Export... Export Hex Values to File...

Transfer Configuration Settings

From GUI to FW Data From FW Data to GUI

Transfer Firmware Parameters

Set Bootloader Release Code

FW Data

Download Recall Read

Checksums

	By Software	By Hardware	FWD
User	6B3B	0	0
ScioSense		46F	46F

Figure 16: Firmware Data page

The settings for the firmware data are stored in the project files, but can also be imported/exported.

You can read the firmware data that are in the chip by means of a recall and read and then transfer them into the GUI parameter settings (firmware data include the configuration).

Vice versa, you can transfer the configuration from the GUI into the firmware data and with a download into the non-volatile RAM of the chip.

For more details about how to write your own firmware please take a look into the application note: "AS6031/40 How to write custom firmware". <https://www.sciosense.com/wp-content/uploads/documents/SC-001548-AN-1-AS60xx-How-to-Write-Custom-Firmware.pdf>

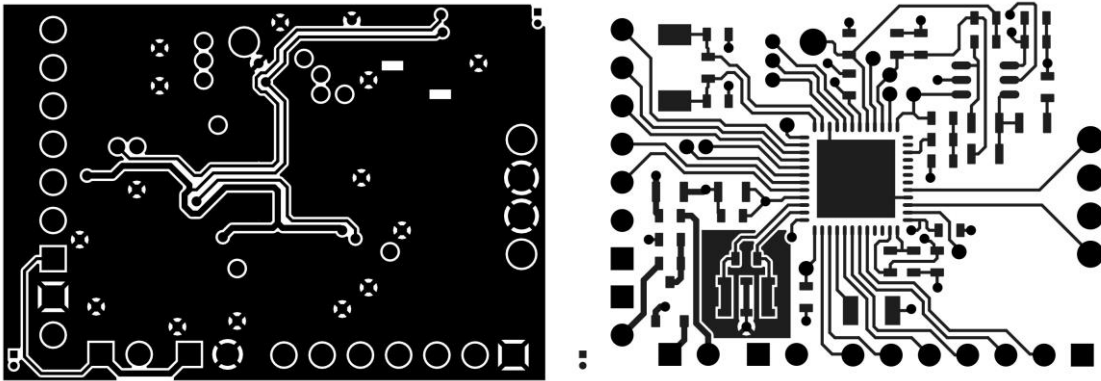

Figure 18: AS6031-QF_DK_RB layout 2:1t

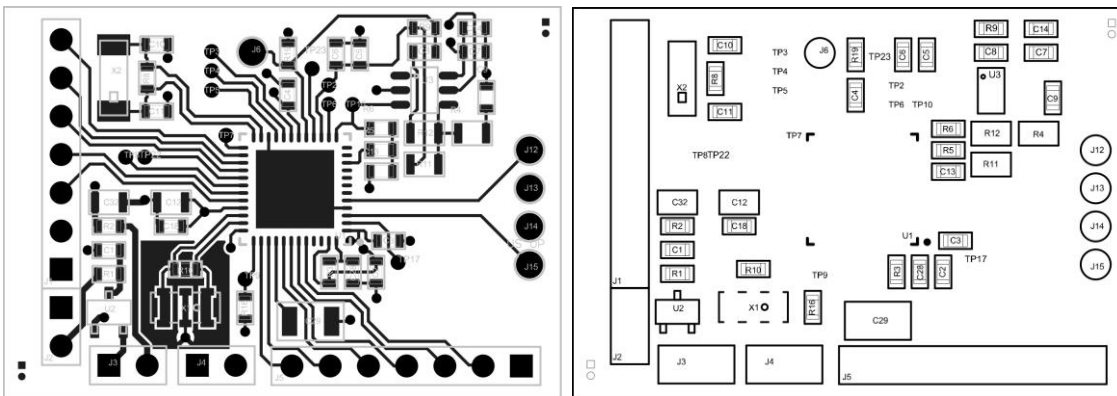

Figure 19: AS6031-QF_DK_RB assembly 2:1

Table 2: Bill of materials for AS6031-QF_DK_RB V2.0

Quantity	Designator	Value	Comment	Footprint
3	C1, C10, C11	10p	C603	0603
1	C2	nc	C603	0603
5	C3, C4, C5, C7, C28	100n	C603	0603
1	C6	680n	C603	0603
1	C8	0R	C603	0603
1	C9	330n	C603	0603
2	C12, C32	100u	C805	0805
1	C13	10n	C603	0603

1	C14	2u2	C603	0603
1	C18	22p	C603	0603
1	C29	100n C0G	C1206	1206R
2	J1, J5		ST/254_7_1R	ST/254_7_1R
3	J2, J3, J4		ST/254_2	ST/254_2
5	J6, J12, J13, J14, J15		PAD1.8mm	PAD1.8mm
3	R1, R2, R3	4R7	R603	0603
2	R4, R11	1k	R805	0805
1	R5	5.6k	R603	0603
1	R6	2.2k	R603	0603
1	R8	10M	R603	0603
1	R9	nc	R603	0603
1	R10	560k	R603	0603
1	R12	22k	R805	0805
1	R16	1k	R603	0603
1	R19	1M	R603	0603
12	TP2, TP3, TP4, TP5, TP6, TP7, TP8, TP9, TP10, TP17, TP22, TP23		PAD1mm	PAD1mm
1	U1		AS6031-BQF	48QFN_7x7
1	U2	3,0V	XC6206	SOT23_TOREX
1	U3		LMP7711	SOT23_6
1	X1	8MHz	Q/CSTCR_G+	Q/CSTCR_G - CSTNE8MHz
1	X2	32,768kHz	Q/KX-327XS	Q/KX-327XS

6 RoHS Compliance & ScioSense Green Statement

RoHS: The term RoHS compliant means that Sciosense B.V. products fully comply with current RoHS directives. Our semiconductor products do not contain any chemicals for all 6 substance categories, including the requirement that lead does not exceed 0.1% by weight in homogeneous materials. Where designed to be soldered at high temperatures, RoHS compliant products are suitable for use in specified lead-free processes.

ScioSense Green (RoHS compliant and no Sb/Br): ScioSense Green defines that in addition to RoHS compliance, our products are free of Bromine (Br) and Antimony (Sb) based flame retardants (Br or Sb do not exceed 0.1% by weight in homogeneous material).

Important Information: The information provided in this statement represents Sciosense B.V. knowledge and belief as of the date that it is provided. Sciosense B.V. bases its knowledge and belief on information provided by third parties, and makes no representation or warranty as to the accuracy of such information. Efforts are underway to better integrate information from third parties. Sciosense B.V. has taken and continues to take reasonable steps to provide representative and accurate information but may not have conducted destructive testing or chemical analysis on incoming materials and chemicals. Sciosense B.V. and Sciosense B.V. suppliers consider certain information to be proprietary, and thus CAS numbers and other limited information may not be available for release.

7 Copyrights & Disclaimer

Copyright Sciosense B.V High Tech Campus 10, 5656 AE Eindhoven, The Netherlands. Trademarks Registered. All rights reserved. The material herein may not be reproduced, adapted, merged, translated, stored, or used without the prior written consent of the copyright owner.

Devices sold by Sciosense B.V. are covered by the warranty and patent indemnification provisions appearing in its General Terms of Trade. Sciosense B.V. makes no warranty, express, statutory, implied, or by description regarding the information set forth herein. Sciosense B.V. reserves the right to change specifications and prices at any time and without notice. Therefore, prior to designing this product into a system, it is necessary to check with Sciosense B.V. for current information. This product is intended for use in commercial applications. Applications requiring extended temperature range, unusual environmental requirements, or high reliability applications, such as military, medical life-support or life-sustaining equipment are specifically not recommended without additional processing by Sciosense B.V. for each application. This product is provided by Sciosense B.V. "AS IS" and any express or implied warranties, including, but not limited to the implied warranties of merchantability and fitness for a particular purpose are disclaimed.

Sciosense B.V. shall not be liable to recipient or any third party for any damages, including but not limited to personal injury, property damage, loss of profits, loss of use, interruption of business or indirect, special, incidental or consequential damages, of any kind, in connection with or arising out of the furnishing, performance or use of the technical data herein. No obligation or liability to recipient or any third party shall arise or flow out of Sciosense B.V. rendering of technical or other services.

8 Revision information

Table 3: Revision history

Revision	Date	Comment	Page
2.0	2020 May 19	Change of ownership from ams to SciSense, status to release	All
3.0	2020 Jun 30	Document number changed	All
4.0	2021 Apr 28	Software description now refers to new Software, iESLab plastic spool piece removed	All
5.0	2021 Oct 22	Reference to update schematics and layout of reference board. PICOPROG picture. Transfer into new SciSense layout	All
6.0	2023 Feb 10	Old PICOPROG replaced by new PicoProg Lite. Section for software description added	All

Note(s) and/or Footnote(s):

1. Page and figure numbers for the previous version may differ from page and figure numbers in the current revision.
2. Correction of typographical errors is not explicitly mentioned.

Address: Sciosense B.V.
High Tech Campus 10
5656 AE Eindhoven
The Netherlands

Contact: www.sciosense.com
info@sciosense.com